

red kite

IMPORTANT, RETAIN FOR FUTURE
REFERENCE: READ CAREFULLY

Instruction Leaflet

Dreamer

Bedside Crib

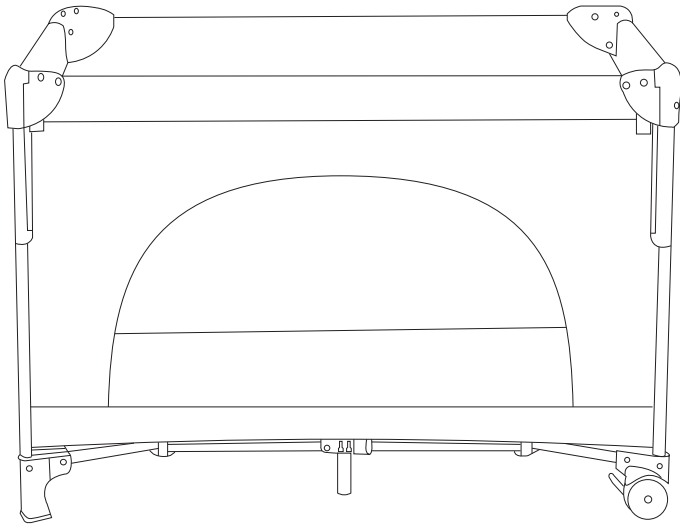

Suitable for babies from birth up to a maximum of 15kg in weight and who are unable to climb out.

Tested to: EN 1130:2019 + AC:2020 EN 716-1:2017+AC:2019 EN 16890:2017+A1:2021

Customer Care: www.redkitebaby.com

Parts list

1. Main crib
2. Bassinette support poles
3. Storage bag
4. Fixing belt
5. Mattress
6. Bassinette

Tools required for assembly: None

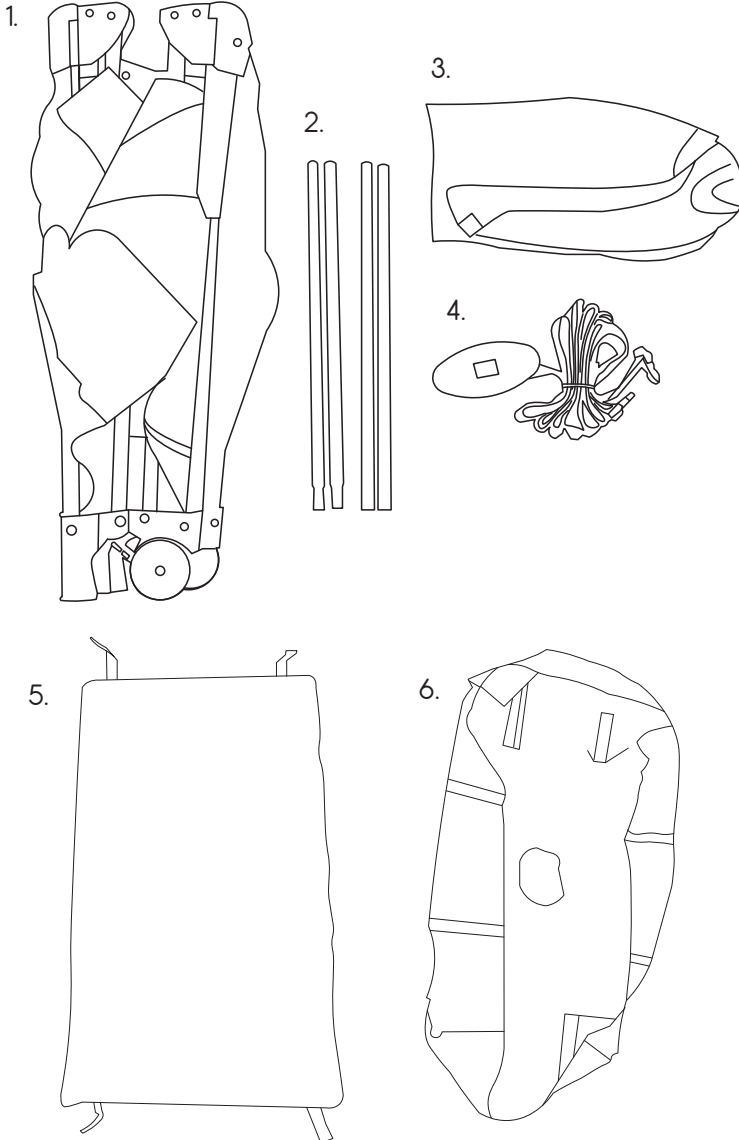

Crib mode

To assemble the crib

1. Undo the Velcro straps to remove the mattress. Fig 1.
2. Make sure the base is in the upright position and then lift each of the side rails upwards until they lock in place. Fig 2.
3. Only when all four top rails are locked, push the base down. Fig 3.
4. Place the mattress inside the cot with the Velcro straps facing downwards. Fig 4.
5. Thread the straps through the slots and secure underneath. Fig 5.

To use the brakes

6. To use the brakes. Press down on the lever to engage them and lift up the lever to release them. Fig 6.

To use the bassinette

7. Zip the bassinette in to the inside of the crib. Fig 7.
8. Thread the loop and eye of the zip through the split ring (Fig 8) and cover with the Velcro flap. Fig 8a.
- Slide the bassinette support poles into the bassinette and connect them together. Fig 8b.
9. Place the mattress inside and secure it to the bassinette with the velcro straps. Fig 9.

To fold for storage

10. Remove the mattress and bassinette poles if used. Using the loop in the bottom centre of the cot, lift up as far as possible. Lift the side rails up and squeeze the unlocking button on the bottom of the rail. With the button held in, lower the rail downwards. Repeat for all side rails. Fig 10.
11. Whilst lifting the loop, pull all four corners together and then wrap the mattress around it and secure with the Velcro straps. Fig 11.

TIPS

Make sure you **DO NOT** push the base of the cot down before you lock the side rails.
Make sure you lift the base of the cot to its highest position before attempting to unlock the rails.

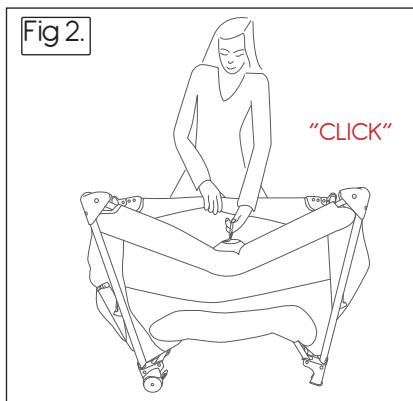
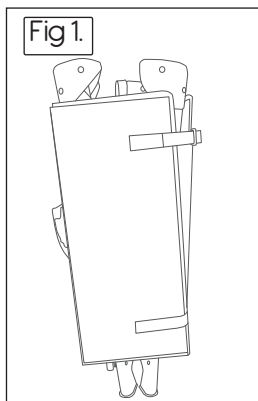

Fig 4.

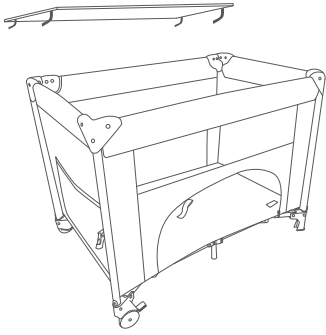

Fig 5.

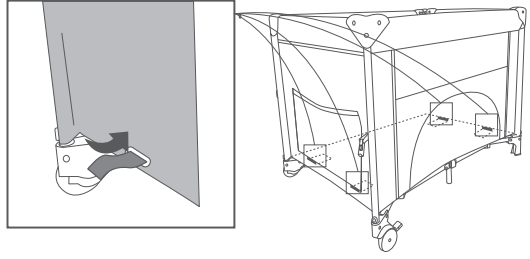

Fig 6.

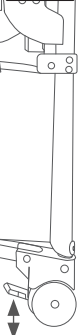

Fig 7.

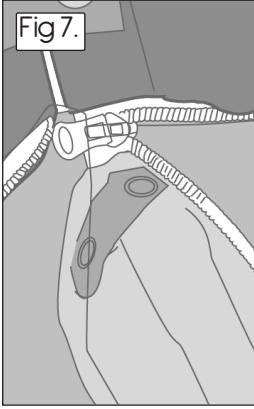

Fig 8.

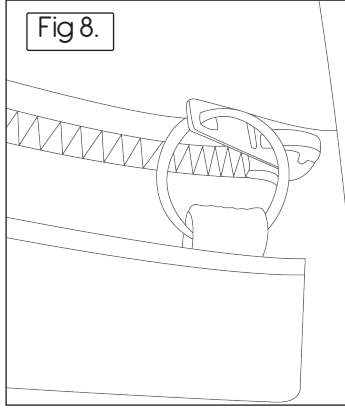

Fig 8a.

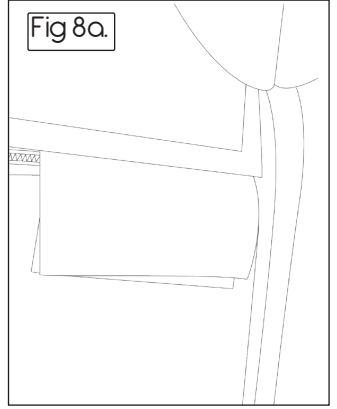

Fig 8b.

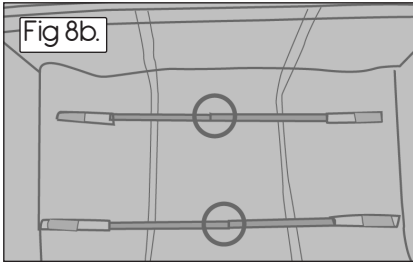

Fig 9.

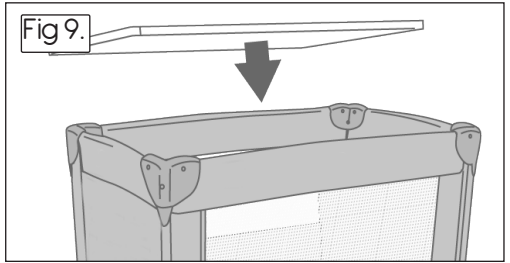

Fig 10.

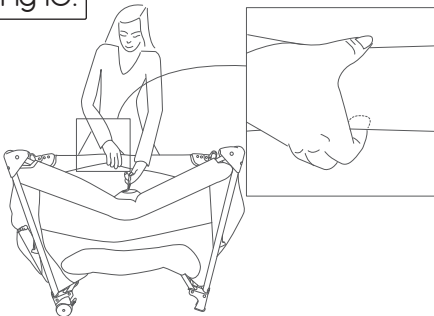

Fig 11.



Co sleeper mode

To use the drop side function

1. To lower the drop side bar, press the buttons on each side of the joints and lower the bar. There are four height positions to choose from. Figs 1a, b and c.

To use in co sleeper mode

2. Thread the fixing belt plate between the adult's mattress and pivot the plate so it lies flat against both the bed base and mattress. Fig 2a. Connect the ends of the fixing belts to the buckles on each end of the cot (Fig 2b) and pull tight by adjusting the sliders. Ensure the cot is tight against the bed with no gap. Fig 2c.

WARNING – To avoid hazards from the child's neck being caught on the top rail on the side that is next to the child's bed, the top rail must not be higher than the adult bed mattress.

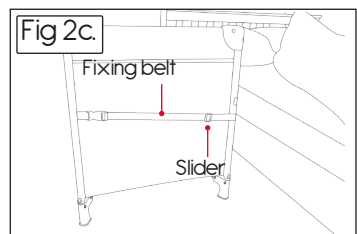
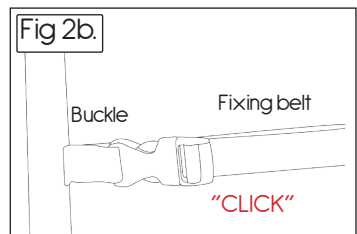
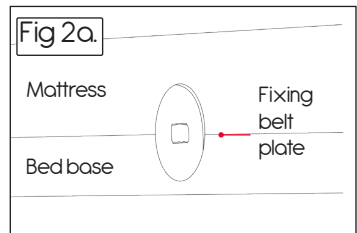
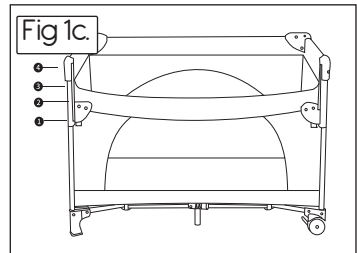
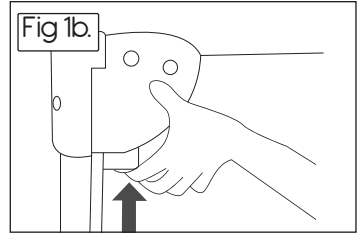
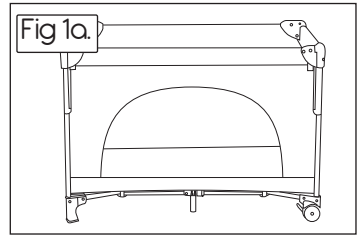
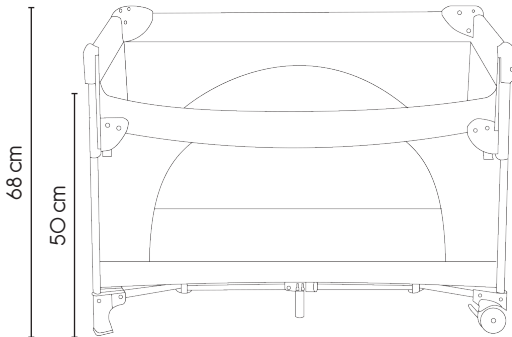
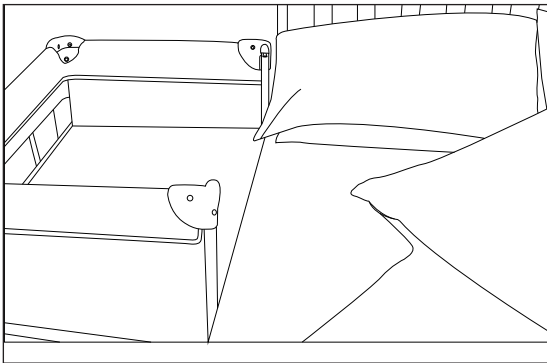

Co sleeper mode

Safety Warnings:

- WARNING – Do not use this product without reading the instructions for use first.
- WARNING – Stop using the product as soon as the child can sit or kneel or pull itself up.
- WARNING – Placing additional items in the product may cause suffocation.
- WARNING – Do not place the product close to another product, which could present a danger of suffocation or strangulation, e.g. strings, blind / curtain cords, etc.
- WARNING – Do not use more than one mattress in the product.
- WARNING – Only use the mattress sold with this crib, do not add a second mattress on this one, suffocation hazards.
- WARNING – To avoid hazards from the child's neck being caught on the top rail on the side that is next to the child's bed, the top rail must not be higher than the adult bed mattress.
- WARNING – To avoid the risk of your child being strangled the attachment system to the adult's bed should always be kept away from and out of the crib.
- DANGER! – Always completely raise the drop side when not attached to the adult's bed.
- Suitable for beds with straight sides. Not suitable for beds with inset / curved mattresses or water beds.
- Only use the attachment system supplied. Do not use another as it may not be suitable.
- The product must always be placed on a horizontal surface. Never leave the product on an inclined. Never use the crib in an inclined position.
- To prevent a suffocation hazard from entrapment, the bedside sleeper shall be properly secured to the adult bed using the attachment system.
- There must never be a gap between the lower side of the bedside sleeper and the mattress of the adult bed.
- Check the tightness of the attachment system before each use by pulling the bedside sleeper in a direction away from the adult bed.
- If there is any gap between the bedside sleeper and the adult bed DO NOT use the product.
- Gaps should not be filled with pillows, blankets or other items.
- Children should not be allowed to play unsupervised in the vicinity of the crib.
- Do not adjust or move the crib with the child inside.
- Suitable for one child only.
- The product must be kept away from electric cables and cords. Do not place the product near windows where cords, curtains or similar objects could pose choking or strangling hazards for the child.
- All assembly fittings should always be tightened properly and that care should be taken that no screws are loose as a child could trap parts of the body or clothing (e.g. strings, necklaces, ribbons for babies dummies, etc.), which would pose a risk of strangulation.

Crib mode

Safety warnings:

- WARNING: Be aware of the risk of open fire and other sources of strong heat, such as electric bar fires, gas fires, etc. in the near vicinity of the cot.
- WARNING: Do not use the cot if any part is broken, torn or missing and use only spare parts approved by the manufacturer.
- WARNING: Do not leave anything in the cot or place the cot close to another product, which could provide a foothold or present a danger of suffocation or strangulation, e.g. strings, blind/curtain cords, etc.
- WARNING: Do not use more than one mattress in the cot.
- Ensure that the product is correctly assembled before use; with the top bars locked straight, the centre foot firmly on the ground and the mattress in position.
- The lowest position is the safest and the base should always be used in that position as soon as the baby is old enough to sit up.
- Always completely raise the drop side when not using crib mode. Use only the mattress supplied with this product and ensure it remains in position.
- To prevent injury from falls, the crib should not be used when a child is able to climb out.
- Children should not be allowed to play unsupervised in the vicinity of the crib.
- Do not adjust or move the crib with the child inside.
- Suitable for one child only.
- The product must be kept away from electric cables and cords.
- Do not place the product near windows where cords, curtains or similar objects could pose choking or strangling hazards for the child.
- All assembly fittings should always be tightened properly and that care should be taken that no screws are loose as a child could trap parts of the body or clothing (e.g. strings, necklaces, ribbons for babies dummies, etc.), which would pose a risk of strangulation.

Bassinette

Safety Warnings:

- WARNING – Suitable for babies who cannot pull themselves up or sit unaided.
- WARNING – Do not use the bassinette when the child can sit or kneel or pull itself up.
- WARNING – Remove all parts of the bassinette before using the cot in it's lowest position.
- The crib base without the bassinet is the safest option and the child must be placed in this lowest position once it can pull itself up or sit unaided.

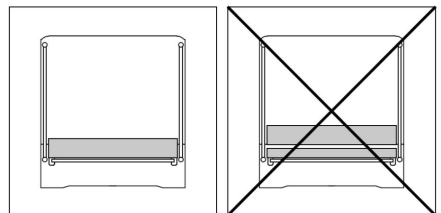

X Additional mattress

General Care:

- This product has been designed and developed with safety, comfort and functionality in mind. Please take the time to read this manual carefully before using this product and keep it in a safe place for future reference.
- Do not use excessive force when adjusting the product.
- Always store the product in a dry place.
- The correct use and maintenance of this product is essential.

Cleaning:

- Fabrics and the mattress may be spot cleaned by using a sponge with a mild soap and warm water solution. Leave to dry in a ventilated area away from direct sunlight. Do not dry clean, machine wash, bleach or tumble dry.
- Metal parts may be cleaned with a damp cloth. Always wipe dry.
- Clean plastic parts with a mild soap and warm water solution. Always wipe dry.
- Avoid leaving the product in direct sunlight for prolonged periods of time as this may cause fabrics to fade.

Maintenance:

- Check that nothing is loose or broken and that no sharp edges have been exposed. Replace any damaged parts immediately.
- Routinely inspect all studs, nuts and screws for tightness. Do not use replacement parts other than those approved by the manufacturer or distributor. Failure to do this may invalidate your warranty.
- DO NOT use crib if any parts are missing, damaged, or broken. Contact Red Kite for replacement parts and instructional literature if needed. DO NOT substitute parts.
- All assembly fittings should always be tightened properly and fittings should be checked regularly and retightened as necessary.

Extra Information:

- Unlike cots that have rigid sides the Dreamer bedside crib has flexible sides. As a result the mattress is specially designed to prevent a suffocation hazard. The mattress has a solid base, a specific length and width and is less than 25mm thick in order to meet the relevant safety standards. Using a thicker or differently sized mattress may allow a child's head to get between the mattress and the side of the crib causing suffocation.
- The mattress size used on this product is 830mm x 510mm x 20mm.
- Do not use for a child that is able to climb out, reaches 86 cm in height or weighs more than 15kgs. (Whichever is first).
- Intended for use by children under 3 years of age.
- Never allow other children to play with the product.
- The crib is designed for baby whilst sleeping not as a restraint device.

Manufactured By:

The Red Kite Baby Co Ltd. 35 Lavenham Road,
Beeches Industrial Estate, Yate, Bristol, BS37 5QX. UK.

Authorised Representative:

Mum n Me. Triq is-Suq, Zejtun, ZTN1420. Malta.

